

ASPEN

DECORATIVE GAS APPLIANCE

Installation and Operating Instructions



**INSTALLER: PLEASE LEAVE THIS MANUAL WITH THE CUSTOMER
CUSTOMER: PLEASE KEEP INSTRUCTIONS FOR FUTURE REFERENCE**

FOR YOUR SAFETY

DO NOT store or use gasoline or any other flammable vapors or liquids in the vicinity of this or any other appliance.

IF YOU SMELL GAS:

- Do not try to light any appliance.
- Open windows.
- Do not touch electrical switches.
- Do not use any phone in your building.
- Extinguish any open flame.
- Immediately call your gas supplier from a neighbor's phone. Follow the gas supplier's instructions.
- If you cannot reach the gas supplier, call the fire department.

PLEASE READ INSTRUCTIONS CAREFULLY BEFORE INSTALLING AND OPERATING THE APPLIANCE

WARNING: If the information in these instructions are not followed exactly a fire or explosion may result causing property damage, personal injury or loss of life. Installation and service must be performed by a qualified installer, service agency or the gas supplier.

Massachusetts: The gas piping and the final gas connection must be performed by a licensed plumber or gas fitter in the state of Massachusetts.

SAFETY NOTICE

- FIREPLACE MUST BE PROPERLY INSTALLED AND MAINTAINED OR A HOUSE FIRE MAY RESULT.
- FOR YOUR SAFETY, FOLLOW THE INSTALLATION INSTRUCTIONS.
- CONTACT LOCAL BUILDING OFFICIALS ABOUT RESTRICTIONS AND INSTALLATION INSPECTION.
- FAILURE TO COMPLY WITH OWNER'S MANUAL INSTRUCTIONS WILL VOID WARRANTY.

Made in the USA by:
Aspen Industries Inc
480 Country Club drive
Bensenville, IL 60106

Please read this entire
manual before
installation.

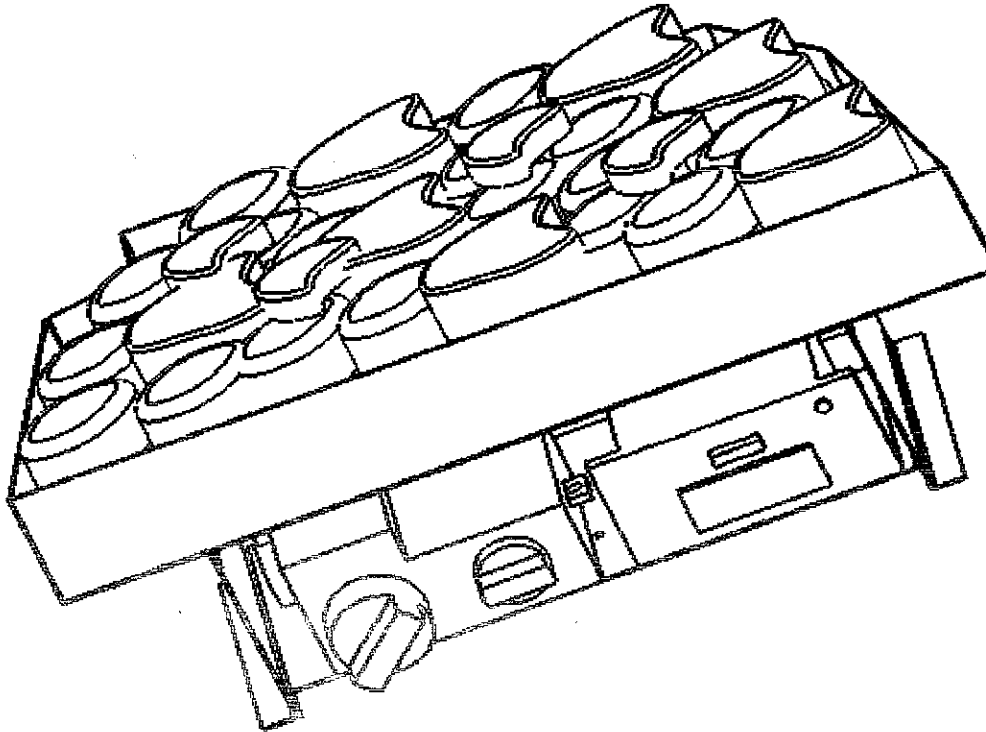

Dealer _____

Installer _____

Phone _____

Installation Date _____

Serial Number _____

This appliance is suitable for installation in a bedroom or bed sitting room. This appliance may be installed in an aftermarket permanently located, manufactured (mobile) home, where not prohibited by local codes. This appliance is only for use with the type of gas indicated on the rating plate. This appliance is not convertible for use with other gases, unless a certified kit is used.

LISTING AND CODES

The model ***** is listed and certified for installation in the U.S.A. and Canada under the following standards:

- ANSI Z21.50b/CGA 2.23-2000b, *Vented Gas Fireplace.*

Please contact Aspen Industries Inc, if you have any questions regarding the certification of this appliance.

Index of Contents

LISTING AND CODES.....2

INSTALLER INFORMATION.....2

WARNING NOTICES.....4

SPECIFICATIONS.....5

LABEL COPY.....6

INTRODUCTION AND SAFETY INFORMATION.....7

IMPORTANT INFORMATION.....8

MINIMUM INSTALL DIMENSIONS.....9

GAS LINE INSTALLATION.....10

BURNER AND SUPPLY CHECK.....11

INSTALLATION CHECK LIST.....12

OPERATION.....13

TROUBLESHOOTING.....14

REPLACEMENT PART LISTS.....15

APPENDIX 'A' (GRATE COAL EFFECT PLACEMENT)

IF THIS APPLIANCE IS NOT PROPERLY INSTALLED, A HOUSE FIRE, OR EXPLOSION MAY RESULT. FOR YOUR SAFETY, FOLLOW THE INSTALLATION DIRECTIONS. CONTACT LOCAL BUILDING OR FIRE OFFICIALS ABOUT RESTRICTIONS AND INSTALLATION REQUIREMENTS IN YOUR AREA. PLEASE READ THIS ENTIRE MANUAL BEFORE YOU INSTALL AND USE YOUR NEW APPLIANCE. FAILURE TO FOLLOW INSTRUCTIONS MAY RESULT IN PROPERTY DAMAGE, BODILY INJURY OR DEATH.

Safe installation and operation always require common sense. We are also required by Canadian and ANSI safety standards to point out the following:

INSTALLATION AND REPAIR SHOULD BE DONE BY A QUALIFIED SERVICE PERSON. THE APPLIANCE SHOULD BE INSPECTED BEFORE USE AND AT LEAST ANNUALLY BY A PROFESSIONAL SERVICE PERSON. MORE FREQUENT CLEANING MAY BE REQUIRED DUE TO EXCESSIVE LINT FROM CARPETING, BEDDING MATERIAL, ET CETERA. IT IS IMPERATIVE THAT CONTROL COMPARTMENTS, BURNERS AND CIRCULATING AIR PASSAGEWAYS OF THE APPLIANCE BE KEPT CLEAN.

IT IS IMPERATIVE THAT CONTROL COMPARTMENTS, BURNERS AND CIRCULATING AIR PASSAGEWAYS OF THE APPLIANCE ARE KEPT CLEAN.

DUE TO HIGH TEMPERATURES, THE APPLIANCE SHOULD BE LOCATED OUT OF TRAFFIC AND AWAY FROM FURNITURE AND DRAPERIES.

DO NOT USE THIS HEATER IF ANY PART HAS BEEN UNDER WATER. IMMEDIATELY CALL A QUALIFIED SERVICE TECHNICIAN TO INSPECT THE HEATER AND TO REPLACE ANY PART OF THE CONTROL SYSTEM AND ANY GAS CONTROL WHICH HAS BEEN UNDER WATER.

CLOTHING OR OTHER FLAMMABLE MATERIALS SHOULD NOT BE PLACED ON OR NEAR THE APPLIANCE.

COMBUSTION AIR MUST BE PROVIDED FOR THE OPERATION OF THIS UNIT.

ANY SAFETY SCREEN OR GUARD REMOVED FOR SERVICING A ROOM HEATER MUST BE REPLACED PRIOR TO OPERATING THE APPLIANCE.

NEVER VENT THE APPLIANCE INTO OTHER ROOMS OR BUILDINGS. THE APPLIANCE MUST BE VENTED ONLY TO THE OUTSIDE.

THIS APPLIANCE MUST NOT BE CONNECTED TO A CHIMNEY FLUE SERVING A SEPARATE SOLID-FUEL BURNING APPLIANCE.

CHILDREN AND ADULTS SHOULD BE ALERTED TO THE HAZARDS OF HIGH SURFACE TEMPERATURES AND SHOULD STAY AWAY TO AVOID BURNS OR CLOTHING IGNITION.

YOUNG CHILDREN SHOULD BE CAREFULLY SUPERVISED WHEN THEY ARE IN THE SAME ROOM AS THE APPLIANCE.

SPECIFICATIONS

| MODEL ASPEN | Natural Gas (NG) | Propane (LP) |
|---|--------------------------|--------------------------|
| Manifold Pressure Royal | 1.6 - 3.5 in. w.c. | 5.5 - 11.0 in. w.c. |
| Manifold Pressure Royal ZC | 1.6 - 2.1 in. w.c. | 5.5 - 6.4 in. w.c. |
| Min. Supply Pressure for Purpose of Input Adjustment | 5.00 in. w.c. (1.2 kPa) | 13.0 in. w.c. |
| Max. Supply Pressure for Purpose of Input Adjustment | 7.0 in. w.c. | 15.0 in. w.c. |
| Orifice Size | 29# DMS | 53# DMS |
| Nominal Input Rating | 28,500 BTU/hr | 28,500 BTU/hr |
| Nominal Input Rating Royal ZC. | 21,500 BTU/hr | 21,500 BTU/hr |
| Altitude | 0 - 2,000ft. (0 - 610 m) | 0 - 2,000ft. (0 - 610 m) |
| Primary Air Opening | Fixed | Fixed |
| Log Set | Ceramic coal effect | Ceramic coal effect |

HIGH ALTITUDE INSTALLATION

When installing this appliance over 2000ft above sea level, the appliance must be properly derated as required by local codes.

This appliance must be installed as required by local codes, in the absence of local codes in accordance with CAN/CGA-B149, in Canada. In the US the appliance must be installed in accordance with the current National Fuel Gas Code, ANSI Z223.1/ NFPA 54.



Serial No.

Logo Here

Vented Decorative Gas Appliance
 This Fireplace is factory equipped for 0-608m (0-2000ft)
 Cette chaufferette est équipée en usine pour une élévation de 0 à 608m (0-2000 pi)



MODEL: Royal

Aspen Industries Inc
 480 Country Club Drive
 Bensenville, IL 60106

Tested to ANSI Z21.50-2001b /CSA 2.23-M2001b, "Vented Decorative Gas Appliance" Certified / Certifié pour le Canada ET U.S.A.

| MODEL: Echo | NATURAL GAS <input type="checkbox"/> | LP GAS |
|---|--------------------------------------|--------------------------------|
| Orifice (DMS) 610 / 0-2000 ft | 29# DMS | 53# DMS |
| Input rating (BTU/hr / Kw) 610m 2,000 ft Alt | 28,500BTU/hr (8.4kw) | 28,500BTU/hr (8.4kw) |
| Evaluation de la consommation (BTU/hr / Kw) 610-1370m 2000-4500' d'altitude | 28,500BTU/hr (8.4kw) | 28,500BTU (8.4kw) |
| Minimum Input (BTU/hr / Kw) | 19,000 BTU/hr (5.6kw) | 19,000 BTU/hr (5.6kw) |
| Consommation minimale (BTU/hr / Kw) | 19,000 BTU/hr (5.6kw) | 19,000 BTU/hr (5.6kw) |
| Manifold Pressure (In w.c. / kPa) | 3.5" | 11.0" |
| Collecteur de pression (In w.c. / kPa) | 3.5" | 11.0" <input type="checkbox"/> |
| Manifold Pressure Lo setting (In w.c. / kPa) | 1.6" | 5.5" |
| Collecteur de pression à bas rendement (In w.c. / kPa) | 1.6" | 5.5" |
| Minimum Inlet Pressure (In w.c. / kPa) | 5.0" | 13.0" |
| Entrée de pression minimale (In w.c. / kPa) | 5.0" | 13.0" |

This appliance must be installed in accordance with local codes if any: if none, follow the *National Fuel Gas Code*, ANSI Z223.1 or *Canadian Installation Codes*, CAN 1-B149. Cet appareil doit être installé selon les normes locales (si existantes): si non, suivre le code d'installation pour appareils au gaz ANSI Z223.1 et CAN1-B149.

CAUTION: HOT WHILE IN OPERATION, DO NOT TOUCH, SEVERE BURNS MAY RESULT KEEP CHILDREN, CLOTHING AND FURNITURE AWAY. KEEP GASOLINE AND OTHER LIQUIDS HAVING FLAMMABLE VAPORS AWAY. KEEP BURNER AND CONTROL COMPARTMENT CLEAN, SEE INSTALLATION AND OPERATING INSTRUCTIONS ACCOMPANYING APPLIANCE. THIS APPLIANCE NEEDS FRESH AIR FOR SAFE OPERATION AND MUST BE INSTALLED SO THERE ARE PROVISIONS FOR ADEQUATE AIR, IMPROPER INSTALLATION, ADJUSTMENT, ALTERATION, SERVICE OR MAINTENANCE CAN CAUSE INJURY OR PROPERTY DAMAGE. AND MAY VOID WARRANTY. REFER TO THE OWNER'S INFORMATION MANUAL PROVIDED WITH THIS APPLIANCE. FOR ASSISTANCE OR ADDITIONAL INFORMATION CONSULT A QUALIFIED INSTALLER, SERVICE AGENCY OR THE GAS SUPPLIER.

WARNING: OPERATION OF THIS APPLIANCE WHEN NOT CONNECTED TO A PROPERLY INSTALLED AND MAINTAINED VENTING SYSTEM OR TAMPERING WITH THE BLOCKED VENT SHUTOFF SYSTEM CAN RESULT IN CARBON MONOXIDE (CO) POISONING AND POSSIBLE DEATH. THIS APPLIANCE NEEDS FRESH AIR FOR SAFE OPERATION AND MUST BE INSTALLED SO THERE ARE PROVISIONS FOR ADEQUATE COMBUSTION AND VENTILATION AIR. VENTED GAS FIREPLACE HEATER—NOT FOR USE WITH SOLID FUEL. THIS VENTED GAS FIREPLACE IS NOT FOR USE WITH AIR FILTERS. THIS APPLIANCE MUST BE PROPERLY CONNECTED TO A VENTING SYSTEM IN ACCORDANCE WITH THE MANUFACTURER'S INSTRUCTIONS. NOT FOR USE WITH GLASS DOORS. FOR INSTALLATION INTO NON COMBUSTIBLE FIREPLACES ONLY.



Serial No.

Logo Here

Aspen Industries Inc
480 Country Club Drive
Bensenville, IL 60106



MODEL: Royal ZC

Tested to ANSI Z21.50.-2001b /CSA 2.23-M2001b, "Vented Decorative Gas Appliance" Certified / Certifié pour le Canada ET U.S.A.

| MODEL: Echo | NATURAL GAS | LP GAS |
|---|----------------------------------|----------------------------------|
| Orifice (DMS) 610 / 0-2000 ft | 29# DMS <input type="checkbox"/> | 53# DMS <input type="checkbox"/> |
| Input rating (BTU/hr / Kw) 610m 2,000 ft Alt | 21,500 BTU/hr (8.4kw) | 21,500 BTU/hr (8.4kw) |
| Evaluation de la consommation (BTU/hr / Kw) 610-1370m 2000-4500' d'altitude | 21,500 BTU/hr (8.4kw) | 21,500 BTU (8.4kw) |
| Minimum Input (BTU/hr / Kw) | 19,000 BTU/hr (5.6kw) | 19,000 BTU/hr (5.6kw) |
| Consommation minimale (BTU/hr / Kw) | 19,000 BTU/hr (5.6kw) | 19,000 BTU/hr (5.6kw) |
| Manifold Pressure (In w.c. / kPa) | 2.1" | 6.4" |
| Collecteur de pression (In w.c. / kPa) | 2.1" | 6.4" |
| Manifold Pressure Lo setting (In w.c. / kPa) | 1.6" | 5.5" |
| Collecteur de pression à bas rendement (In w.c. / kPa) | 1.6" | 5.5" |
| Minimum Inlet Pressure (In w.c. / kPa) | 5.0" | 13.0" |
| Entree de pression minimale (In w.c. / kPa) | 5.0" | 13.0" |

This appliance must be installed in accordance with local codes if any: if none, follow the *National Fuel Gas Code, ANSI Z223.1* or *Canadian Installation Codes, CAN 1-B149*. Cet appareil doit être installé selon les normes locales (si existantes): si non, suivre le code d'installation pour appareils au gaz ANSI Z223.1 et CAN1-B149.

CAUTION: HOT WHILE IN OPERATION, DO NOT TOUCH, SEVERE BURNS MAY RESULT KEEP CHILDREN, CLOTHING AND FURNITURE AWAY. KEEP GASOLINE AND OTHER LIQUIDS HAVING FLAMMABLE VAPORS AWAY. KEEP BURNER AND CONTROL COMPARTMENT CLEAN, SEE INSTALLATION AND OPERATING INSTRUCTIONS ACCOMPANYING APPLIANCE. THIS APPLIANCE NEEDS FRESH AIR FOR SAFE OPERATION AND MUST BE INSTALLED SO THERE ARE PROVISIONS FOR ADEQUATE AIR, IMPROPER INSTALLATION, ADJUSTMENT, ALTERATION, SERVICE OR MAINTENANCE CAN CAUSE INJURY OR PROPERTY DAMAGE. AND MAY VOID WARRANTY. REFER TO THE OWNER'S INFORMATION MANUAL PROVIDED WITH THIS APPLIANCE. FOR ASSISTANCE OR ADDITIONAL INFORMATION CONSULT A QUALIFIED INSTALLER, SERVICE AGENCY OR THE GAS SUPPLIER.

WARNING: OPERATION OF THIS APPLIANCE WHEN NOT CONNECTED TO A PROPERLY INSTALLED AND MAINTAINED VENTING SYSTEM OR TAMPERING WITH THE BLOCKED VENT SHUTOFF SYSTEM CAN RESULT IN CARBON MONOXIDE (CO) POISONING AND POSSIBLE DEATH. THIS APPLIANCE NEEDS FRESH AIR FOR SAFE OPERATION AND MUST BE INSTALLED SO THERE ARE PROVISIONS FOR ADEQUATE COMBUSTION AND VENTILATION AIR. VENTED GAS FIREPLACE HEATER—NOT FOR USE WITH SOLID FUEL. THIS VENTED GAS FIREPLACE IS NOT FOR USE WITH AIR FILTERS. THIS APPLIANCE MUST BE PROPERLY CONNECTED TO A VENTING SYSTEM IN ACCORDANCE WITH THE MANUFACTURERS INSTRUCTIONS. NOT FOR USE WITH GLASS DOORS. FOR INSTALLATION INTO NON COMBUSTIBLE FIREPLACES ONLY.

INTRODUCTION AND SAFETY INFORMATION

Aspen Industries, would like to thank you for choosing our model royal series Gas appliance. Whether you are hooking up to a natural gas or liquid propane gas, please read the following safety information thoroughly before installing or lighting your new gas heater. Improper installation will void your warranty, but, more importantly, incorrect installation and/or hook-up could result in serious injury and even loss of life. Follow these instructions closely and do not deviate from them without the permission of licensed and trained personnel knowledgeable of the installation and operation of gas appliances.

If You Smell Gas:

- Extinguish any open flame.
- Do not light any appliance.
- Do not plug in or unplug any electrical plug or switch.
- Open windows and vacate building.
- Call gas supplier from a phone outside of your house or if unable to reach supplier, call fire department (also from phone outside of your house).

Safety Check Before Installation

This appliance must be installed by a licensed and qualified installer to prevent the possibility of explosion. This instruction manual must be strictly adhered to. Do not use makeshift methods or compromise the installation in any way. Improper installation will void the warranty and safety listing.

This appliance is approved for either natural gas or LP (liquid propane) gas. Burning the incorrect fuel will void the warranty and safety listing and could cause extreme hazard. Make sure you have the

proper gas valve for the fuel being used. The gas valve is clearly marked natural gas or LP gas.).

Permit

Contact your local building officials and obtain a permit before beginning installation. Notify your insurance company and provide them with the proper inspection documents indicating that the appliance has been installed to code and inspected and also passed inspection.

Flammables

Do not store or use gasoline or other flammable liquids in the vicinity of the heater.

Airflow

Always keep control compartment and fan air passageways free of lint and dust and obstructions. Do not place clothing or other flammable items on or near the heater. The heater can be controlled by a thermostat and will come on automatically if the thermostat option is hooked up and utilized. **Educate small children that external portions of the heater are extremely hot! Young children should be supervised if they are in the same room with the heater.**

Adequate air must be provided for combustion and accessibility for serving

Safe Operation

Operate this heater in accordance with the instructions in this manual. Light the pilot and burner using built-in piezo lighter. Do not use matches or any other lighting device external to your appliance. If the pilot or main burner do not light correctly, turn off the gas at the gas control valve.), and call your dealer or service person. If the flame becomes sooty, dark orange in color, or extremely tall and lazy, do not operate the heater. Call your dealer.

Do not operate the heater if Any portion of the heater has been submerged in water or any corrosion occurs. Do not operate if you suspect any improper operation. Call your dealer.

Coals

Always allow the heater to cool before carrying out any maintenance or cleaning. (see Maintenance section). Do not place anything inside the firebox area except authorized Aspen factory coal effect pieces. If the coals become damaged, replace with factory-authorized coals. Never remove, replace, modify, or substitute any part of this appliance unless given instructions to do so by factory-trained personnel or professionally licensed and certified gas technicians.

Safety Check Conclusion

Do not throw this Owner's Manual away. This manual contains important hook-up, operation, and

maintenance instructions that you may need in the future. Aspen Industries grants no warranty, implied or stated, for the installation and maintenance of your heater and assumes no responsibility of any consequential damages as a result of improper installation or failure to perform routine maintenance.

Venting Configuration

The fireplace shall be installed with a minimum of 12ft vertical rise and a maximum of 6" horizontal run.

IMPORTANT INFORMATION

This appliance must be installed in accordance with all local codes, if any. If not, follow ANSI 223.1, NFPA 54, NFPA 70, CAN/CGA B149 current editions.

Please record the following information and keep this manual as a permanent document for your records in case you require service in the future.

Model: (Check one) Aspen Vent Natural Gas
 Aspen Vent Liquid Propane

Purchase Date: _____ Serial Number: _____

Purchased From: _____

Installed By: _____

Mail in your warranty card and save your bill of sale. You will need to show this evidence of date of purchase to receive full warranty coverage.

MINIMUM INSTALL DIMENSIONS

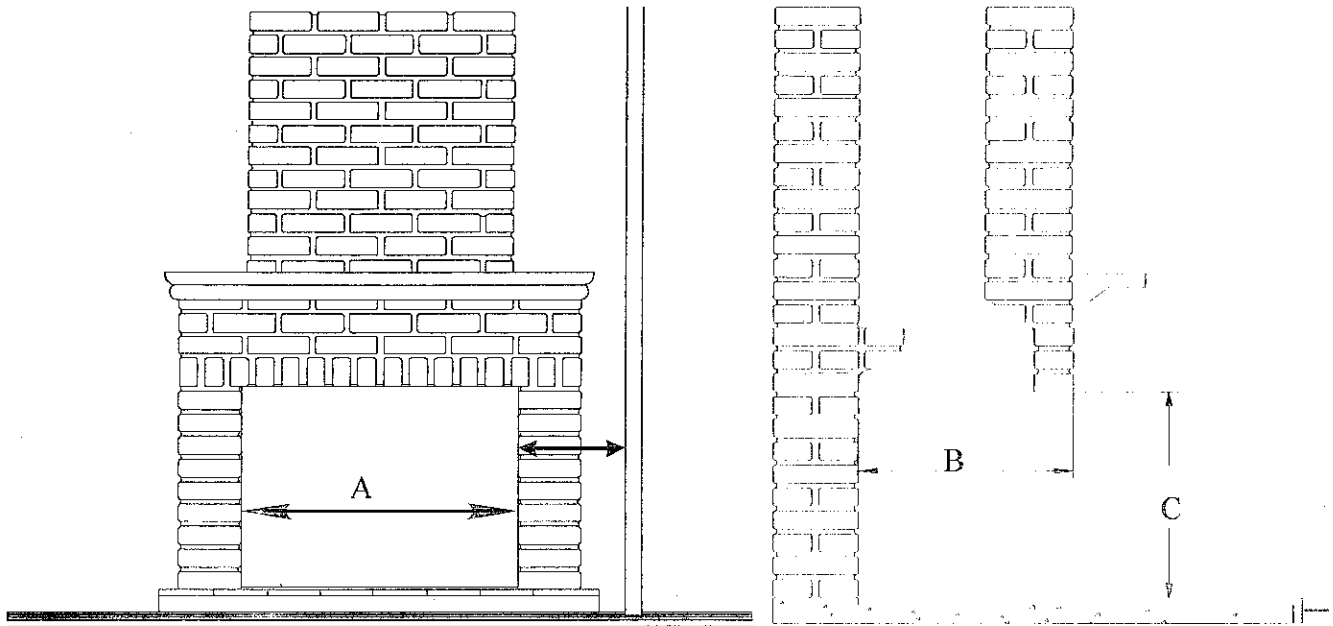

Minimum Dimensions

- A - 19"
- B - 9"
- C - 21"

Gas Line Installation

ONLY PERSONS LICENSED TO WORK WITH GAS PIPING MAY MAKE THE NECESSARY GAS CONNECTION TO THIS APPLIANCE. YOU ARE NOW READY TO HOOK UP THE GAS SUPPLY. BE SURE GAS PLUMBING INSTRUCTIONS AND ALL PROVINCIAL AND LOCAL CODES ARE CAREFULLY FOLLOWED. USE APPROVED FLEXIBLE GAS CONNECTIONS OR RIGID PIPING, DEPENDING ON PROVINCIAL AND LOCAL CODES, TO ATTACH BURNER TO GAS SUPPLY. BE SURE TO USE PROPER SIZE GAS SUPPLY LINE. CAREFULLY CHECK ALL CONNECTIONS FOR GAS LEAKS WITH SOAP AND WATER SOLUTION. EACH INSTALLATION MUST CONFORM TO ALL LOCAL, PROVINCIAL AND NATIONAL CODES. REFER TO THE NATIONAL FUEL GAS CODE, LOCAL ZONING AND CODE AUTHORITIES FOR DETAILS ON INSTALLATION REQUIREMENTS.

Existing gas supply

Before interrupting the existing gas supply it is recommended that the following be checked.

Shut down all gas appliances and carry out a pressure test to insure there are no existing leaks on the system. Before connecting the appliance to the gas supply line, double check that the appliance you have purchased is designed for the gas type you are using. The gas type markings are located on the certification label and also on the appliance's gas valve.

Check the gas pressure to insure you will be able to supply the minimum inlet pressure for the appliance. Check your pipe sizing to insure sufficient volume will be supplied to the appliance.

Gas supply installation

Provide adequate clearance for proper installation and checking of the gas connections.

Have your gas supplier or a qualified gas fitter run a gas supply line into the gas fireplace. The line must be properly sized and fitted according to the installation codes. Upstream of the appliance supply connection, the fitter shall provide an easily accessible manual shut-off valve.

The gas supply pipe should enter the appliance case through the opening at the rear left side. The supply pipe should be

connected to the appliance gas inlet pipe situated at the left side of the control unit. Supply line connection to the inlet pipe is

3/8 NPT.

Use only new black iron or steel pipes or copper tubing if acceptable - check local codes. *Note that in USA copper tubing*

must be internally tinned for protection against sulfur compounds.

- Unions in gas lines should be of ground joint type.
- Sealant used must be resistant to the action of all gas constituents including LP gas. Sealant should be applied lightly to male threads to ensure excess sealant does not enter gas lines.

Pressure testing the supply line for leaks

The appliance and its individual shut-off valve must be disconnected from the gas supply piping system during any pressure testing of that system at test pressures in excess of 1/2 psig (3.5 kPa). The appliance must be isolated from the gas supply piping system by closing its individual manual shut-off valve during any pressure testing of the gas supply piping system at test pressures equal to or less than 1/2 psig (3.5 kPa). Failure to do so will damage the appliance's gas valve. Such damage is not covered by the manufacturer's warranty.

When testing for leaks:

- Make sure that the appliance is turned off.
- Open the manual shut-off valve.
- Test for leaks by applying a liquid detergent or soap solution to all joints. Bubbles forming indicate a gas leak.
- ***Never use an open flame to check for leaks.***
- Correct any leak detected immediately.

The pressure test tapping locations are built-in to the non-adjustable regulator.

The correct pressure range is shown in the table in Specifications section of this manual. The pressure check should be made with the burner lit.

See lighting instruction section for full operating details.

BE SURE TO TIGHTEN THE PRESSURE TAP SET-SCREW AFTER CHECKING THE PRESSURE. CHECK ALL GAS CONNECTIONS FOR GAS LEAKS.

Aeration Setting Check

Aeration is factory set with the model *** there is no need to adjust the any primary air setting. However, the flame picture should be checked to ensure correct burning is taking place.

Poor flame picture may be a sign of poor air circulation around the unit.

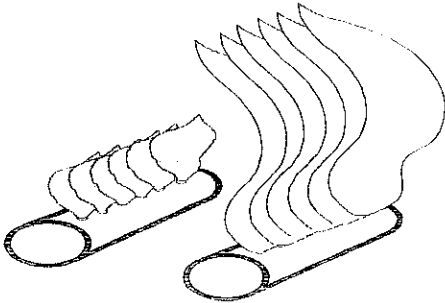
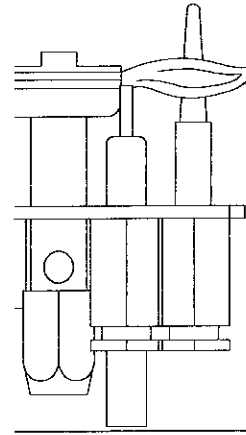

Open - Short blue flame

Closed - tall yellow flame

Burner & pilot checks

A periodic check of the pilot and burner flames should be made. Check after the fire has been on for at least 30 minutes. The pilot flame must cover the tip of the thermocouple probe, if the pilot flame does not sufficiently cover the probes it can be adjusted using the pilot adjustment screw found on the front of the gas valve. The main burner flame pattern will vary from appliance to appliance depending on the type of installation and climatic conditions.

INSTALLATION CHECKLIST

Check off the following list before proceeding to light the heater.

- There are no combustibles placed within 36" of heater or vent pipe or any combustibles that can swing within 36" of heater such as door drapes, etc.
- The location of the main shut off valve is known by everyone in the house (it is usually next to the gas meter or propane tank). EVERYONE must know where this valve is located.
- All necessary permits and installation information have been obtained and the final inspection has been performed by the local building inspector.
- The operation instructions located on the gas valve panel door have been read and understood. A copy of these instructions can be found in the "Operations" section of this manual.
- The operator and pilot igniter have read this manual thoroughly and understand it.

OPERATION

1. Push the gas control knob in slightly and turn clockwise to the "Off" position. NOTE: The knob will not turn from "On" to "Off" unless the knob is depressed. Do not force!
2. Wait five (5) minutes to clear out any gas, then again smell for gas, including near the floor. If you smell gas, STOP and follow the instructions outlined at the beginning of this manual.

LIGHTING THE PILOT

STOP! Read the following safety information before lighting.

This heater is equipped with an ignition device which must be lighted by hand. When lighting the pilot, follow these instructions exactly.

Before lighting, smell all around the appliance area for gas. Be sure to smell next to the floor because gas can be heavier than air and it will settle on the floor.

IF YOU SMELL GAS, FOLLOW INSTRUCTIONS OUTLINED AT THE BEGINNING OF THIS MANUAL!

If you do not smell gas, proceed as follows:

1. Set the thermostat to the lowest setting (if applicable).

If you do not smell gas, push in the control valve and turn the control knob counter-clockwise to the "Pilot" position.

2. When the control knob is turned to the pilot position a click will be heard, this is the spark ignition. Check pilot has lit. If the pilot does not light turn the knob clockwise until you hear a click and attempt to re-spark the pilot. If after 3 try's the pilot does lit, wait five minutes before retrying. Hold in the control knob button until the pilot stay lit. This may take up to 30 seconds once the pilot is lit.
3. Release the gas control knob. If the pilot goes out, repeat Step 6.
4. Turn the gas control knob counter-clockwise to "On."

5. Set the thermostat to the desired setting (if applicable) and turn the burner switch to "On." The main burner will then ignite.

Initial Burn, Fan, and Flame

The first time you use your heater, you will smell paint. This odor is from the paint curing on the outside of the heater. This is normal. The initial flame will at first be blue. It will become more yellow and "fire like." You can adjust the flame height using the Hi/Lo flame adjustment.

Normal Sounds

On start-up you might hear a whisper sound from the pilot, a clicking in the gas control valve, and a whirring sound as the fan turns on. These sounds are all normal.

WARNING: Do not burn heater if glass is cracked or broken. See "Maintenance" for replacing glass.

MAINTENANCE

Make sure that there is adequate clearance for accessibility to service and operate the appliance. Always verify proper operation after servicing. Every year you should inspect your fire box, burner, and glass gasket to make sure they are clean and functioning properly.

WARNING: Failure to inspect and maintain your appliance may lead to improper burning inside the appliance and could create a dangerous situation.

Burner, Firebox, Vent and Pilot Inspection

The firebox should be inspected for any soot or dust build-up that might occur during operation. There should be no soot in the firebox except where the flame might brush against the coals. If you find soot you may need an adjustment by your dealer or service technician. Visually inspect the pilot for soot build-up, proper flame height, and any obstruction. This inspection should be done periodically to ensure proper performance. Periodic inspection of the vent system by a qualified agency.

TROUBLESHOOTING

WARNING: All servicing and troubleshooting of gas controls and high voltage circuits should be done by a qualified service technician.

As a guide to help you understand the functioning and potential problem areas in your heater, use the following chart. When in doubt, do not hesitate to call your service representative or the gas supplier who furnishes you with natural gas or propane.

| PROBLEM | POSSIBLE CAUSE |
|---|--|
| Pilot will not light | <ul style="list-style-type: none"> ▪ A gas shut-off valve is turned off ▪ The gas control valve is turned to pilot ▪ The gas control valve wasn't pushed in and/or the igniter wasn't pushed repeatedly |
| Main burner does not come on | <ul style="list-style-type: none"> ▪ The pilot has gone out ▪ The burner on/off switch is turned off ▪ The thermostat is disconnected or set too high |
| Thermostat does not work | <ul style="list-style-type: none"> ▪ Pilot has gone out ▪ On/Off switch is turned to Off ▪ Thermostat is set too high |
| Flame is dirty and orange, and glass is sooty | <ul style="list-style-type: none"> ▪ Logs are not placed properly or something may be obstructing burn ▪ Air adjustment may be required by a service technician |
| Flames are too short | <ul style="list-style-type: none"> ▪ Hi/Lo flame adjust knob is turned too low |

REPLACEMENT PARTS LIST

Replacement parts are available at your dealer. Contact Aspen Industries inc. for information on the closest dealer. The parts listed below are the only parts that the consumer may replace. All other parts must be replaced by a qualified gas service person.

| PART | DESCRIPTION |
|-------------------------|-----------------------------|
| Coal Kit | Ceramic Coal effect pieces |
| Burner media | Filter material for burner |
| Mertik gas valve | Gas control valve |
| Pilot Assembly | Thermocouple, pilot housing |
| Remote control assembly | Remote control device |
| Owner's Manual | This document |

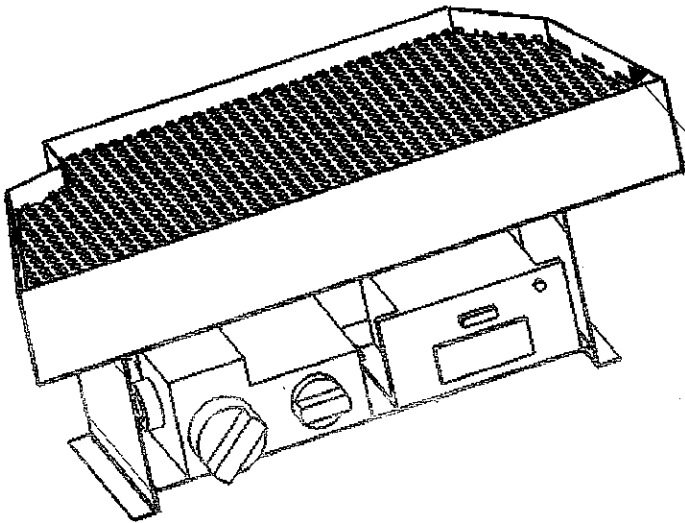
APPENDIX A – ASPEN GRATE COAL EFFECT PLACEMENT

Pour in the filter burner media and level out the top so that it is approximately $\frac{3}{4}$ " from the top lip. Make sure that there is no other material present.

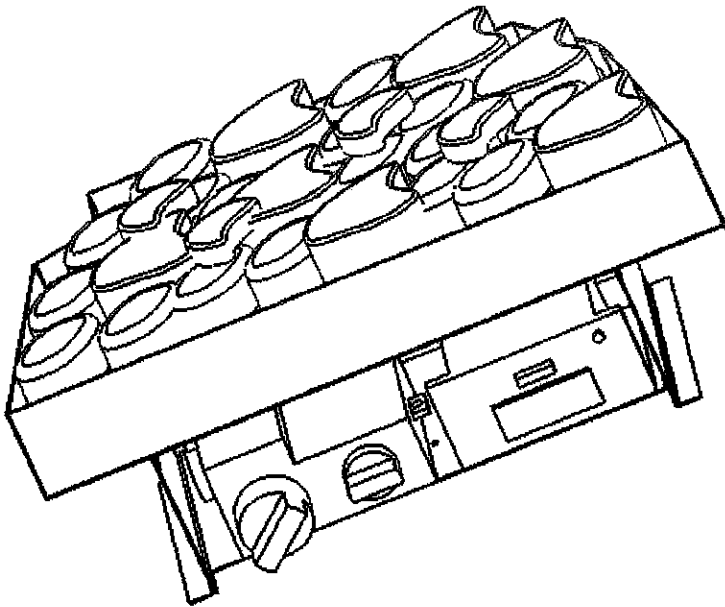

Place the coals over the ember bed. Place one level of coals and then add a few more overlapping towards the center.

Lit the unit and observe the flame, slightly adjust the coals to suit.

WARNING: Do not place any material other than that supplied by Aspen Industries in this unit

Failure to follow this instruction may result in property damage or personnel injury

SAFETY WARNING INSTRUCTIONS

BULLETIN MM2070-10/98
replaced MM2067

FOR MERTIK MAXITROL GV30 SERIES GAS COMBINATION CONTROLS

SPECIAL WARNINGS

IF YOU DO NOT FOLLOW THESE INSTRUCTIONS EXACTLY, A FIRE OR EXPLOSION MAY RESULT CAUSING PROPERTY DAMAGE, PERSONAL INJURY OR LOSS OF LIFE.

NO UNTRAINED PERSON SHOULD ATTEMPT TO INSTALL, MAINTAIN OR SERVICE GAS PRESSURE CONTROLS.

To minimize the possibility of FIRE, EXPLOSION, and OTHER HAZARDS:

1. All products, including gas pressure controls, used with combustible gas **must** be installed and used **strictly** in accordance with the instructions of the manufacturer, with government codes and regulations, and plumbing codes and practices.
2. Do **not** use a gas combination control if it appears to have been subjected to high temperatures, damaged in any way, or to have been taken apart or tampered with. Any of these may be signs of possible leakage or other damage that may affect proper operation and cause potentially dangerous combustion problems.
3. **Installation**
 - a. Turn off gas supply before starting installation.
 - b. Install the control properly so gas will flow as indicated by the arrow on the casting.
 - c. Make sure markings or wording on control are not painted over or obliterated.

Mounting positions (see diagrams below)

- d. The gas control can be mounted horizontally 0 to 90 degrees in any direction from the upright position, i.e. from the position when the knobs are on top. It can also be mounted in a vertical position.

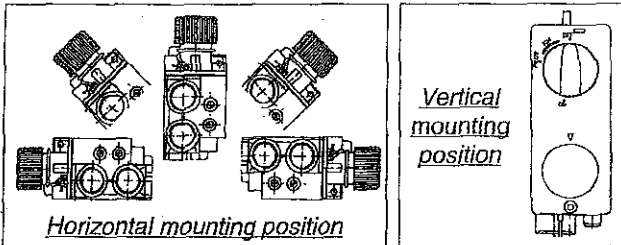

Main gas NPT connections (inlet or outlet)

- e. Use joint compound/thread sealant, properly threaded pipes and careful assembly procedure so that there is no cross threading, etc., which can cause damage or leakage.
- f. Apply light pressure only at wrench flats (See Figure 1) to avoid damage to control body, which can result in leakage or malfunction of control. Do not apply pressure to top casting or plastic cover.

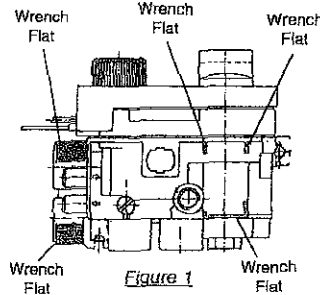

Main gas (outlet only) and/or *side outlet tubing connection

- g. Square off end of tubing and remove burrs.
- h. Slip gland and ferrule over tubing.
- i. Insert tubing into the outlet until it bottoms, slide ferrule and gland into place and turn finger tight. Do not use joint compound.
- j. Use a wrench to tighten gland about one turn beyond finger tight. (*If side outlet model, do not rotate outlet in its threads to avoid possible leakage.)

Pilot gas connection (tubing only)

- k. Square off the end of tubing and remove burrs.
- l. Slip compression fitting over tubing. Insert tubing into pilot outlet connection until it bottoms, slide fitting into place and turn finger tight.
Do not use joint compound.
- m. Use a wrench to tighten fitting about 1-1/2 turn beyond finger tight.
- n. Connect other end of tubing to pilot burner according to the manufacturer's instructions.

CAUTION

DO NOT BEND TUBING AT SPACE HEATER GAS CONTROL AFTER COMPRESSION FITTING HAS BEEN TIGHTENED, AS THIS MAY RESULT IN GAS LEAKAGE AT THE CONNECTION.

Thermocouple connection

- o. The gas control has an electrical thermocouple connection and must therefore be kept clean and dry; joint compound should never be applied to it. Tighten only 1/4 turn beyond finger tight in order to make a good electrical connection. When muting the thermocouple tubing, do not bend it too sharply (min. radius 2.5 mm).

Bulb Location and Mounting

- p. Temperature sensing element is to be located and mounted by the OEM and is not to be changed without consulting factory or qualified serviceman. The temperature sensing element should be placed in a location representative of desired temperature. **Never place directly in flame.** (See Specifications on back page)
4. Check carefully for gas leaks immediately after the control has been installed and the gas turned on. **Do this before attempting to operate the appliance or other gas burning device.** Use a rich soap solution (or other accepted leak tester) to check all flanges, knobs, joints, and piping connections. Wipe clean with a damp rag. It is a good practice to periodically check for leakage during use of the appliance. **Absolutely no leakage should occur, otherwise there is a danger of fire or explosion depending upon conditions. Never use if leakage is detected.**

CAUTION

NEVER CONNECT CONTROL DIRECTLY TO THE PROPANE SUPPLY SOURCE. LP APPLICATIONS REQUIRE AN EXTERNAL REGULATOR (NOT SUPPLIED). INSTALL THE EXTERNAL REGULATOR BETWEEN THE PROPANE SUPPLY SOURCE AND MERTIK MAXITROL CONTROL.

5. Adjustments and Final Checkout

WARNING

ADJUSTMENTS MUST BE MADE BY QUALIFIED PERSONS ONLY. BEFORE ADJUSTMENTS CAN BE MADE, THE COVER SHOULD BE REMOVED. IF THE APPLIANCE MANUFACTURER SUPPLIES CHECKOUT AND/OR SERVICE AND MAINTENANCE INSTRUCTIONS, CAREFULLY FOLLOW THEM. IF THESE INSTRUCTIONS ARE NOT PROVIDED THEN USE THE FOLLOWING PROCEDURE.

(over)

ASPEN COMPANY LIMITED LIFETIME WARRANTY

Aspen Industries Inc. warrants the Royal Series Decorative log set against defects in material and workmanship for Lifetime from the date of purchase with the exception of the electrical components, gaskets, logs, moving parts, gas valve and control, and burner which are warranted for a period of one (1) year from date of purchase. This warranty does not include service call cost or any other additional charges. Check with dealer from whom the appliance was purchased for all costs when arranging a warranty call.

Exclusions to this limited Lifetime warranty include: Injury due to malfunction of the product, loss, damage, defect, failure to function, due to an accident, negligence, misuse, improper installation, alteration or adjustment of the manufacturer's settings, lack of proper and regular maintenance, damage incurred while in transit, or an act of God.

Only the original purchaser of this unit is covered by this limited Lifetime warranty. If the unit is used for commercial purposes, it is excluded from this warranty. The warranty is automatically voided if the unit's serial number has been removed or altered in any way or the wrong fuel has been used.

No dealer, distributor, or similar person has the authority to represent or warrant Aspen Industries Inc. products beyond the terms contained in this limited Lifetime warranty. Aspen Industries Inc. assumes no liability for such representations or warranties.

THIS LIMITED WARRANTY IS THE ONLY WARRANTY SUPPLIED BY ASPEN INDUSTRIES INC., (UNLESS AN EXTENDED WARRANTY HAS BEEN PURCHASED) THE MANUFACTURER OF THE UNITS. ALL OTHER WARRANTIES, WHETHER EXPRESS OR IMPLIED, ARE HEREBY EXPRESSLY DISCLAIMED AND PURCHASER'S RECOURSE IS EXPRESSLY LIMITED TO THE WARRANTIES SET FORTH WITHIN.

HOW TO USE THIS WARRANTY: If you find this unit to be defective in material and/or workmanship, contact your local dealer from whom you purchased the unit. All warranty work must be authorized by the factory in advance of repair and an authorization number assigned. A warranty repair claim form must be signed by both the dealer and the customer. In the event your dealer is no longer in business or you cannot locate a dealer, you may do the following: Call or write factory, giving proof of purchase information and a narrative description of the defect together with your name and address. Only the factory can authorize a heater or part return. Upon authorization by factory, return defective unit or part, freight prepaid to Aspen Industries Inc, Warranty Division. Returned part or product will be repaired or replaced at Aspen Industries Inc option and will be returned to you, freight prepaid, as soon as practical, but not later than 30 days after receipt.

To register your Aspen Industries Inc. warranty, complete and sign the enclosed warranty card and mail it within ten (10) days from date of purchase.

OTHER RIGHTS: This warranty provides you with certain legal rights. You may have additional rights, which vary from state to state in regard to this warranty.

COMPLETE AND SAVE FOR YOUR RECORDS

Date Purchased: _____ Serial Number: _____

Dealer/Retailer where Purchased: _____

Aspen Industries Inc. reserves the right to change, without notice, product features or specifications described.

5. Adjustments and Final Checkout (continued)

Removing cover

- Unscrew the cover screw at the side of the thermostat knob.
- Put a small screw driver in the slotted hole at the side of the operation knob and lift the cover.

Pilot flame adjustment

- Combination control is shipped with pilot flow at maximum.
- Refer to the pilot burner manufacturer's instruction for recommended size of pilot flame.
- if adjustment is required, turn the pilot adjustment screw clockwise to decrease or counterclockwise to increase pilot flame.

Outlet pressure adjustment (a gauge capable of reading inches w.c. is required for any outlet pressure adjustments)

- Remove cover to expose pressure regulator adjustment screw.
- Bring heater to high fire (all burners on maximum). Slowly turn adjustment screw with a small screw driver until the required burner pressure is recorded on the pressure gauge. Turn adjustment screw clockwise to increase or counterclockwise to decrease gas pressure to main burner.

*Side-outlet manual valve minimum flow adjustment

- Combination control is shipped with the side-outlet manual valve set at maximum flow. If adjustment is required perform step g., and then set the manual valve knob (knob - C, Figure 2) to the minimum position.

Turn side-outlet manual valve minimum adjustment screw (Figure 2) clockwise to decrease flow.

(*Do not rotate side outlet in its threads to avoid possible leakage.)

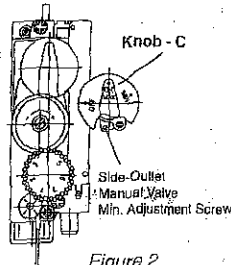

Figure 2 (Shown without cover)

- Replace cover.

Final checkout of the installation

After any adjustment, set appliance in operation. Observe several complete cycles to ensure that all burner components function correctly.

6. Operation

Basic operation

Knob-A (Figure 3) for manual pilot, on-off function, and piezo activation. Knob-B (Figure 3) for temperature level selection with integrated thermostat providing snap action (on-off) and modulation control for minimum to maximum flow.

Ignition interlock

The interlock device prevents the re-establishment of gas flow - when no pilot flame is present - until the thermocouple has cooled sufficiently.

Adjusting temperature

Turn knob-B (Figure 3) toward higher numbers to increase temperature, toward lower numbers to decrease. Remote control versions contain a motor that activates this knob, or it can also be operated manually.

Optional side-outlet control for 2-burner operation

Additional side-mounted manual valve (knob-C, Figure 3) primarily for 2-burner gas fireplace applications.

Lighting procedure

- Turn knob-A (Figure 4) slightly left towards the 'IGN' position until reaching stop, press down and hold for five seconds (only pilot gas flows).
- Continue pressing down while turning further left to activate piezo, continue to hold down for 10 seconds after pilot burner has been lit. If pilot does not light, steps a. and b. can be immediately repeated. (See Note below)
- Upon lighting, release knob and turn further left to 'ON' position (both pilot and main gas flows).

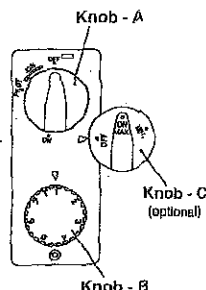

Figure 3 (Shown with cover)

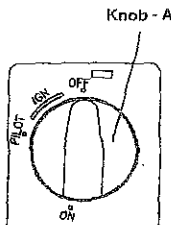

Figure 4

Shut off procedure

- Turn knob-A (Figure 4) right until reaching stop.
- Press down slightly and continue turning right from 'PILOT' position to the 'OFF' position.

When the thermocouple has cooled sufficiently (time will vary based on thermocouple type used), pilot lighting procedure can be repeated. (See Ignition interlock.)

- Very high pressure surges in the gas supply line (or as a result of exposing the system to high pressure) may result in serious internal damage and cause leakage or affect control operation. If you suspect that a Mertik Maxitrol control has been exposed to more than 1-1/2 times its maximum inlet pressure, turn off the gas and have the system checked by an expert.
- The outlet pressure of the control **must** be measured to make sure it is in accordance with intended usage.
- Caution should be used to guarantee that there is sufficient inlet pressure to achieve the desired outlet pressure and no readjustment of the outlet pressure setting should be made unless the inlet pressure is within the proper limits for the control. Failure to follow this may result in overfiring of the appliance or other gas burning device.
- A Mertik Maxitrol combination control must be used within its ambient temperature range, and not in excess of its maximum inlet pressure. The control can be used with all fuel gases.
- In case of any doubt, please contact the Service Manager, Maxitrol Company, Southfield, MI. Phone: 248/356-1400.

12. Specifications

Maximum Operating Inlet Pressure

1/2 psig (34.5 mbar)

Ambient Temperature (Control)

32 ° to 176 °F (0 to 80 °C), or 32 ° to 225 °F (0 ° to 107 °C) for "T" models

Control Range

Capacity: 10,000 - 85,000 BTU/hr

Outlet Pressure: 3" w.c. to 5" w.c. (7.5 to 12 mbar)

8" w.c. to 12" w.c. (20 to 30 mbar)

*Piezo & Cable

Min/Max Spark Gap: 3/4 mm

Min/Max Operating Temperature: -4 ° to 392 °F (-20 ° to 200 °C)

Min/Max Lead Lengths: 150/1000 mm

(*Piezo wire should not be drawn down parallel against lengths of metal - this can result in reduction or loss of power to ignitor. When placing the ignition cable/piezo wire, care should be taken not to stretch it too tightly, if possible, avoid contact with the appliances's metal parts, especially those with sharp edges.)

Maximum Ambient Temperature (Sensor)

Control Range 55 ° - 95 °F: Sensor 122 °F (50 °C)

Control Range 60 ° - 120 °F: Sensor 160 °F (71 °C)

Control Range 85 ° - 175 °F: Sensor 230 °F (110 °C)

Control Range 210 ° - 640 °F: Sensor 715 °F (380 °C)

Hardwired Wall Switch

Use 24 gauge wire or larger for a maximum run of 100 feet

Ultrasonic Remote Control and Receiver

Receiver wire to combination control is rated at 350 °F

Optimal remote operating distance 20 feet

(For best results use fully charged ALKALINE batteries in ambient temperatures less than 125 °F)



WARNING

USE CAUTION WHEN LEAVING AN OPERATING MOTORIZED CONTROL UNATTENDED. ALTHOUGH UNLIKELY, RANDOM SONIC SOUNDS COULD SIGNAL THE ULTRASONIC RECEIVER AND ACTIVATE THE VALVE - LOWER KNOB 'B' COULD ROTATE AND CAUSE THE MAIN BURNER TO COME ON, OR THE FLAME HEIGHT TO ADJUST.

Note: If pilot flame is not established, equipment manufacturer's instructions apply.

GV60 Remote Electronic Ignition and Control System



OPERATING INSTRUCTIONS

FOR OEM USE ONLY



Figure 1



Figure 2



Figure 3



Figure 4



Figure 5



Figure 6



Figure 7

⚠ WARNING

Fire or explosion hazard. Attempted disassembly or repair of controls can cause property damage, severe injury or death.

Read these instructions carefully. Failure to follow them could result in a fire or explosion causing property damage, personal injury, or loss of life. The product must be installed and operated according to all local regulations.

Damper position must be in accordance with Manufacturer's Installation Instructions and all applicable Standards. Failure to follow these Instructions and/or Standards may cause property damage, personal injury, or loss of life.

BEFORE OPERATING verify that no gas is in the area around the appliance, including near the floor.

WHAT TO DO IF YOU SMELL GAS:

- Do not light any appliance.
- Do not touch any electrical switch; do not use any phone in your building.
- Using a neighbor's phone, immediately call the gas supplier. Follow the gas supplier's instructions.
- If you cannot reach the gas supplier, call the fire department.

Use only your hand to push in or turn the gas control knobs. Never use tools. If a knob will not push in or turn by hand, do not try to repair it. Call a qualified service technician. Force or attempted repair may result in a fire or explosion.

Do not use this control or any gas appliance if any part has been under water or in contact with water. Immediately call a qualified service technician to replace the control system and any gas control system which has been under water or in contact with water.

APPLICATION

GV60 is a battery-powered electronic remote ignition and control system for gas appliances with pilot burners and ODS systems.

GENERAL NOTES

Radio Frequency Handset

433.92 MHz for Europe;
315 MHz for U.S. (FCC ID: RTD-G6R) and for Canada (IC: 4943A-G6R).

This device complies with part 15 of the FCC Rules. Operation is subject to the following two conditions: (1) This device may not cause harmful interference, and (2) This device must accept any interference received, including interference that may cause undesired operation. Changes or modifications not expressly approved by the party responsible for compliance could void the user's authority to operate the equipment.

NOTICE

Wiring of valve and receiver must be completed before starting ignition. Failure to do so could damage the electronics.

Batteries - Handset:

- 1x 9V (quality alkaline recommended)
- Low battery indicator on handsets with display
- Handsets without display: the red LED gets darker
- Battery replacement is recommended after 2 years

Batteries - Receiver:

- 4x1.5V "AA" (quality alkaline recommended)
- Low battery indication: frequent beeps for 3 seconds when motor turns.
- An AC Mains Adapter may be used instead of batteries.

NOTICE

Only the Mertik Maxitrol AC Mains Adapter or one preapproved by Mertik Maxitrol can be used. Use of other adaptors can render the system inoperable.

- The module for fan speed control and light/dimmer includes mains power together with batteries in the receiver for automatic backup in case of power outage.
- Without using a mains adapter, battery replacement is recommended at the beginning of each heating season.

NOTICE

The handsets, receivers, wall switches, switch panels and touch pads are not interchangeable with previous electronics (see figure 8).



Figure 8: Previous Handset

SETTING THE ELECTRONICS CODE

(First time use only.)

Radio Frequency Handset

A code is selected automatically for all Mertik Maxitrol electronics from among 65,000 random codes available. The receiver has to learn the code of the handset:

- Press and hold the receiver's reset button (see figure 9) until you hear two (2) beeps. The first beep is short and the second beep is long. After the second beep, release the reset button.
- Within the subsequent 20 seconds press the  (small flame) button on the handset until you hear two additional short beeps confirming the code is set. If you hear one long beep, this indicates the code learning sequence has failed or the wiring is incorrect.

NOTE: This is a one time setting only, and is not required after changing the batteries of the handset or receiver.



Figure 9: Receiver Reset Button

TO TURN ON APPLIANCE

▲ WARNING

When pilot ignition is confirmed, motor turns automatically to maximum flame height.

- Turn MANUAL knob to the ON, full counterclockwise  position.
- Place ON/OFF switch (if equipped) in I (ON position).

Handset

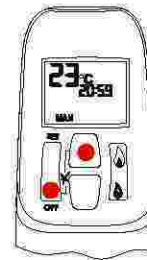

- Simultaneously press the OFF and  (large flame) buttons until a short beep confirms the start sequence has begun; release buttons.
- Continuing beeps confirm the ignition is in process.
- Once pilot ignition is confirmed, there is main gas flow.
- After main burner ignition the handset will automatically go into temperature control mode (CSA version) or manual mode (CE version).

Wall Switch/ Touch Pad/ Switch Panel

- Press button "B" (see figure 10) until a short beep confirms the start sequence has begun; release button.
- Continuing beeps confirm the ignition is in process.
- Once pilot ignition is confirmed, there is main gas flow.

▲ WARNING

If the pilot does not stay lit after several tries, turn the main valve knob to OFF and follow the instructions "TURN OFF GAS TO APPLIANCE" (page 7).

STANDBY MODE (Pilot Flame)

Handset

- Press and hold  (small flame) to set appliance at pilot flame.

Wall Switch/ Touch Pad/ Switch Panel

- Press and hold button "C" (see figure 10) to set appliance at pilot flame.

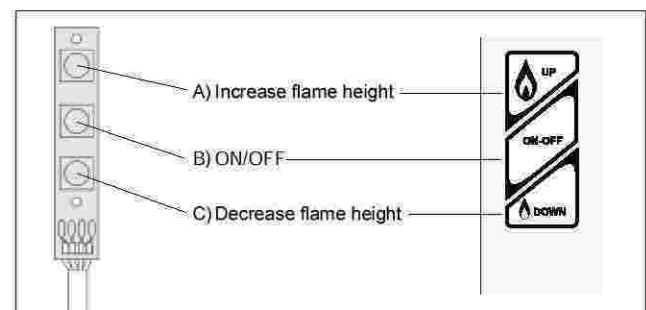

Figure 10: Switch Panel and Wall Switch/Touch Pad

TO TURN OFF APPLIANCE



Handset
 • Press OFF button.

Wall Switch/ Touch Pad/ Switch Panel

- Press button "B" (see figure 10).

FLAME HEIGHT ADJUSTMENT



Handset
 • In standby mode: Press and hold 🔥 (large flame) button to increase flame height.



- Press and hold 🔥 (small flame) button to decrease flame height or to set appliance at pilot flame.
- For fine adjustment tap the 🔥 (large flame) or 🔥 (small flame) buttons.

Wall Switch/ Touch Pad/ Switch Panel
 (See figure 10)

- Press and hold button "A" to increase flame height.
- Press and hold button "C" to decrease flame height or to set appliance at pilot flame.
- For fine adjustment tap button "A" or "C" (see figure 10)

Designated Low and High Fire

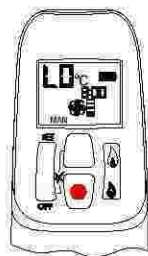

- Double-click 🔥 (small flame) button. "LO" will be displayed.

NOTE: Flame goes to high fire first before going to designated low fire.

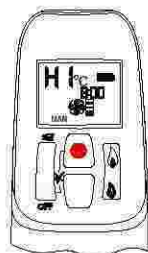

- Double-click 🔥 (large flame) button. Flame automatically goes to high fire. "HI" will be will be displayed.

▲ WARNING

If the appliance will not operate, follow the instructions "TURN OFF GAS TO APPLIANCE" (page 7).

TO OPEN AND CLOSE SOLENOID VALVE/BURNER

NOTE: The latching solenoid valve cannot operate manually. If the battery runs down it will remain in the last operating position. During normal operation the solenoid valve will be reset to the ON position when the GV60 is switched OFF remotely.



Burner OFF

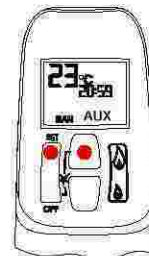

Burner ON

- Upon ignition Main Burner and Decorative Burner are ON.
- Simultaneously press SET and 🔥 (small flame) buttons to switch the Burners OFF. Printed instructions are on the battery cover (see figure 11).
- Simultaneously press SET and 🔥 (large flame) buttons to switch Burner ON. (The AUX symbol on the display indicates the solenoid valve is OPEN.)

NOTE: The operation of the AUX is blocked in timer OFF mode, when the setting of the 🌙 Nighttime Setback Temperature is "--".



Figure 11: Instructions for Latching Solenoid Valve (on battery cover)

MANUAL OPERATION

(Only possible, when MANUAL knob is used)

Access to the pilot burner is only required for ignition with a match.

When turning main valve knob, do not force. Knob has a slip clutch that clicks until the end stops are reached. This allows for manual flame height adjustment as well as adjustment to pilot standby position.

1. **STOP!** Read the safety information included before proceeding.
2. Turn main valve knob to the OFF, full clockwise ↻ position.
3. Turn MANUAL knob to the MAN, full clockwise ↻ position.
4. Place ON/OFF switch (if equipped) in O (OFF position).
5. Wait five (5) minutes to clear out any gas. Verify that no gas is in the area around the appliance, including near the floor. **If you detect gas STOP!** Follow "WHAT TO DO IF YOU SMELL GAS" in the safety information on page 1. If no gas is present, proceed to step 6.
6. Place ON/OFF switch (if equipped) in I (ON position).
7. With the MANUAL knob in MAN position a manual pilot valve operator and piezo ignitor (optional) are accessible.
8. Fully push down manual pilot valve operator and hold in, to start pilot gas flow (see figure 12).

Ignition with match:

Immediately light the pilot with a match, while continuing to hold in the manual pilot valve operator for about one (1) minute after the pilot is lit. Release manual pilot valve operator. If pilot does not stay lit, wait five (5) minutes and repeat.

Ignition with piezo ignitor:

Change the ignition cable from the receiver to the valve (see figure 12). Push in the piezo ignitor to ignite. If pilot does not stay lit, wait five (5) minutes and repeat.

▲ WARNING

If the pilot does not stay lit after several tries, turn the gas control knob (main valve knob) to OFF and proceed to step 12.

9. If applicable, replace pilot access panel before proceeding.
10. Turn MANUAL knob to the ON, full counterclockwise ↻ position.
11. Turn main valve knob to the full ON, full counterclockwise ↻ position.
12. If the appliance will not operate, follow the instructions "TURN OFF GAS TO APPLIANCE".

TURN OFF GAS TO APPLIANCE

1. Place ON/OFF switch (if equipped) in O (OFF position).
2. If gas control is accessible turn main valve knob to the OFF full clockwise ↻ position.
3. Replace appliance access cover (if applicable).

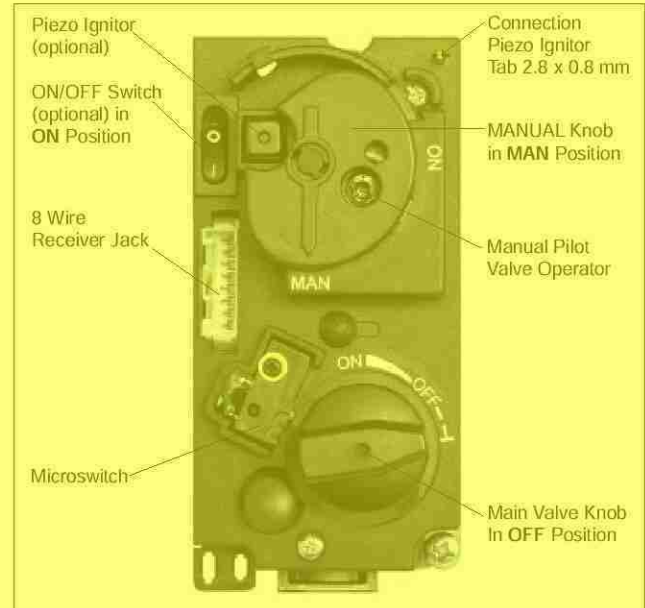

Figure 12: Combination Control, Cover

AUTOMATIC TURN DOWN

6 HOUR NO COMMUNICATION FUNCTION (CE & CSA VERSIONS)

- Manual Mode / Temperature / Timer Mode: The valve will turn to pilot flame if the batteries in the handset are low or if the handset is out of communication range for a 6 hour period.

6 HOUR NO COMMUNICATION FUNCTION (CSA VERSION)

- Manual Mode / Temperature / Timer Mode: The valve will turn to pilot flame if there is no change in flame height for a 6 hour period. In Temperature / Timer Mode if the ambient room temperature changes, the flame height will adjust automatically to maintain set temperature, and the fire will continue to function normally. The valve will turn to pilot flame if the set temperature and the ambient room temperature remain the same over a 6 hour period.

RECEIVER OVERHEATING (FOR MODULE VERSIONS ONLY)

- Valve turns to pilot flame if the temperature in the receiver is higher than 140°F (60°C). The main burner will come back on only when the temperature is below 140°F (60°C).

1 HOUR TURN DOWN FOR SPECIAL RECEIVER (BEDROOM FIREPLACES ONLY)

- The valve will turn to pilot flame if there is no change in flame height over a 1 hour period.

AUTOMATIC SHUT OFF

LOW BATTERY RECEIVER

- With low battery power in the receiver the system shuts off the fire completely. This will not happen if the power supply is interrupted.

FIVE DAY SHUT OFF (CSA VERSION)

- The system shuts off the fire completely if there is no change in flame height for 5 days.

SECOND THERMOCOUPLE SHUT OFF

- Second Thermocouple Option: The system shuts off the fire if the main burner does not completely ignite approximately 20 seconds after ignition or after pushing the  (large flame) button.

NOTE: Before the next ignition there is a 2 minute waiting period.